

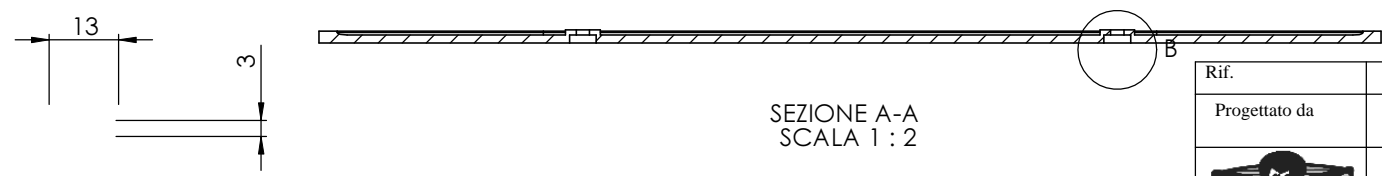

N. rev	Nota di revisione	Data	Firma	Controllo
0	Emissione			

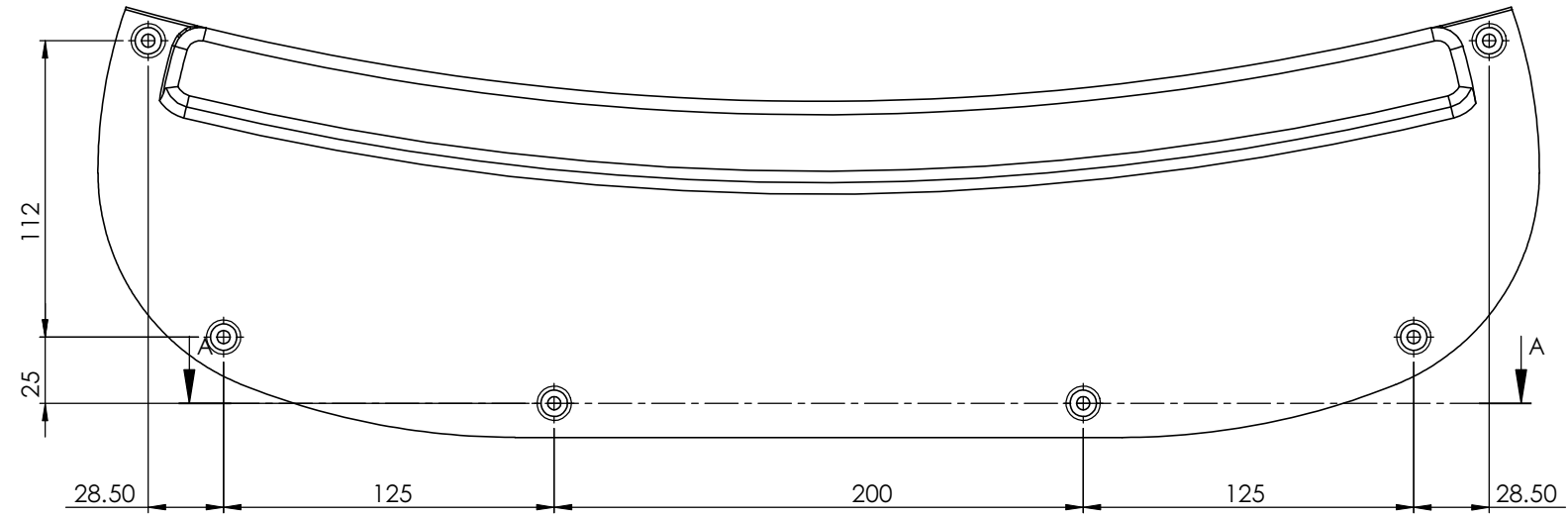
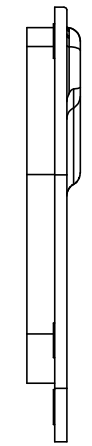
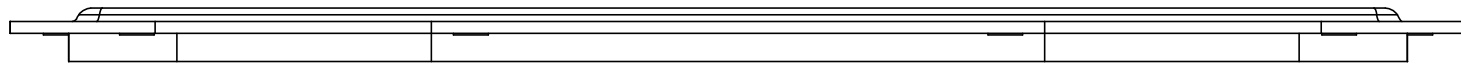
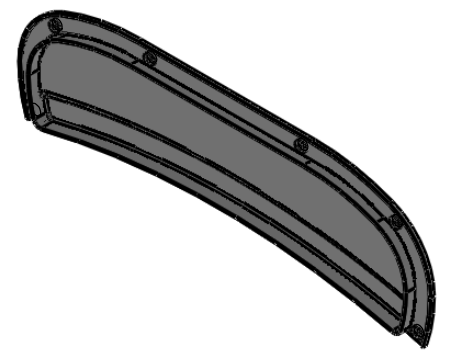
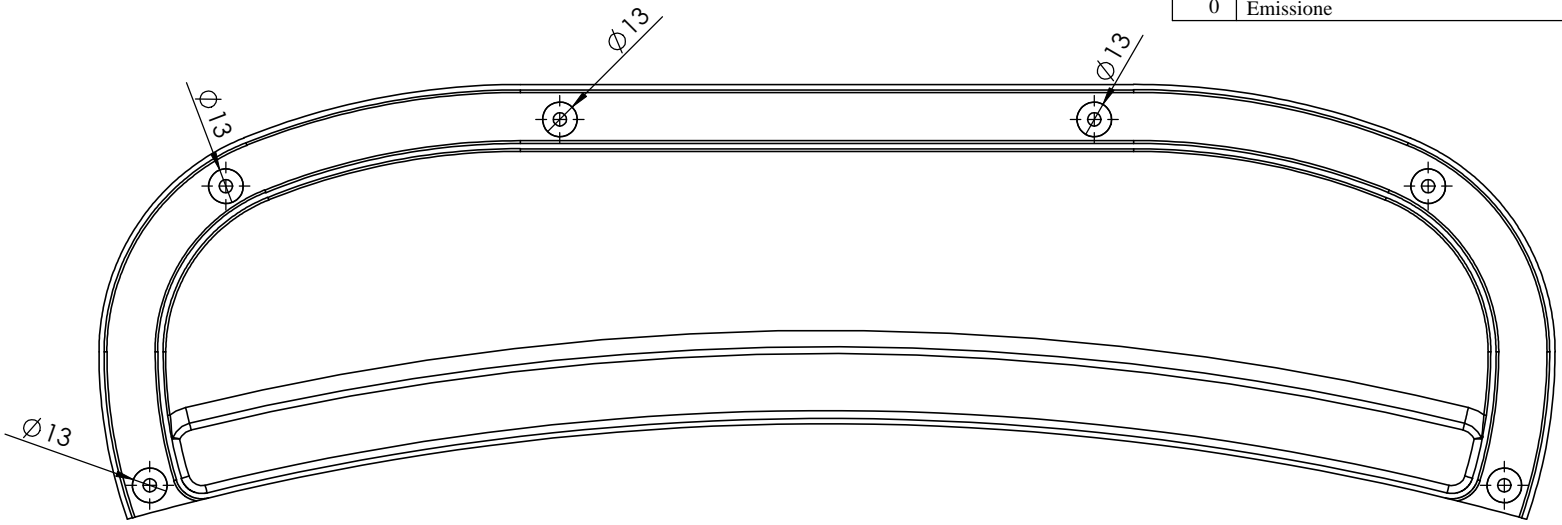

SEZIONE A-A
SCALA 1:2

DETTAGLIO B
SCALA 1:1

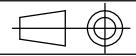
Rif.	Quantità	Tolleranze applicate: UNI ISO 22768-m		Articolo	
Progettato da	Controllato da	Approvato da	Nome file	Data	Scala
		Cliente			
A3		Questo documento è di proprietà esclusiva della TR.EM. srl, qualsiasi riproduzione anche parziale sarà perseguita a norma di legge.		Materiale ?	Foglio 1/1