

N. rev	Nota di revisione	Data	Firma	Controllo
0	Emissione			

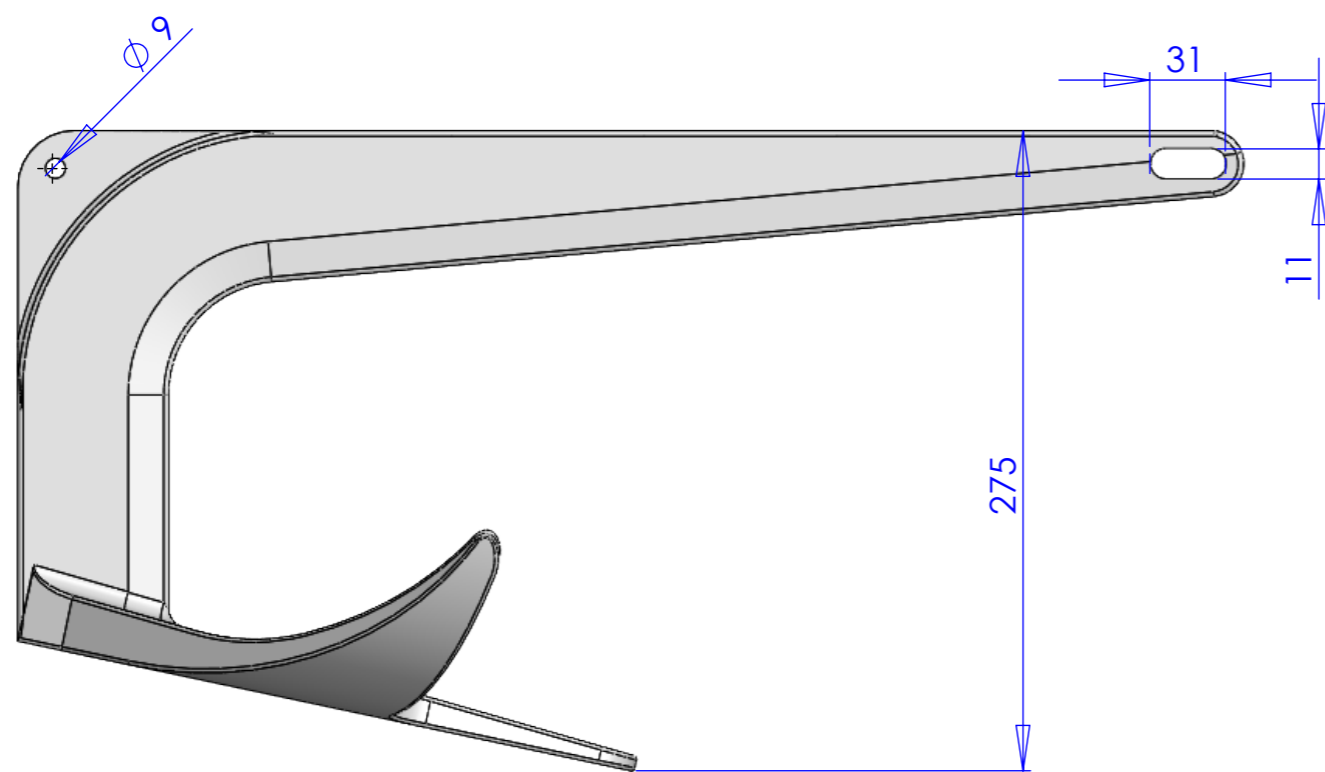
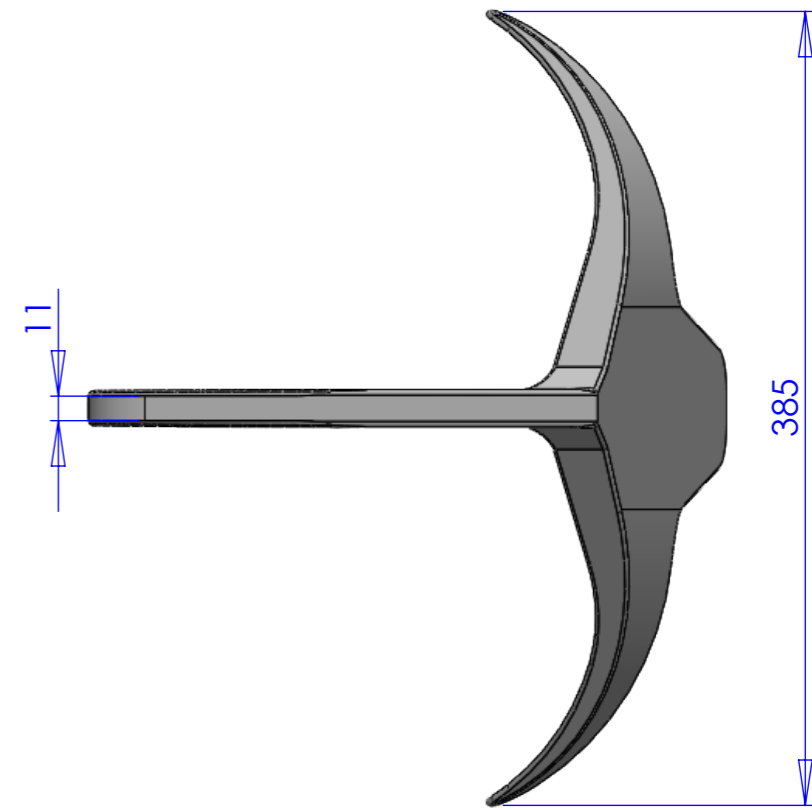
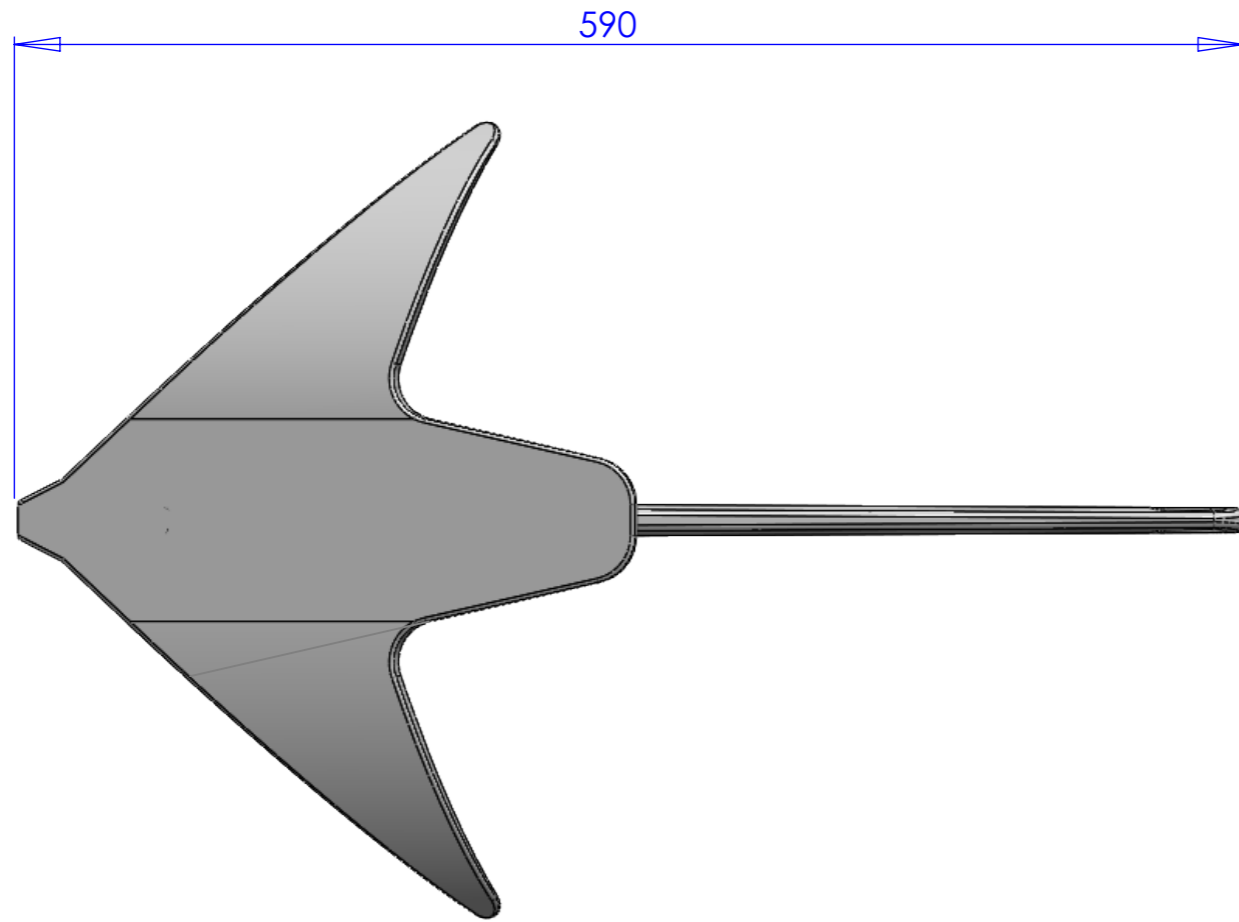

Rif.	Quantità	Tolleranze applicate: UNI ISO 22768-m		Articolo N3732100	
Progettato da	Controllato da	Approvato da	Nome file	Data	Scala
		Cliente Ancora inox 10 kg			
A3		Questo documento è di proprietà esclusiva della TR.EM. srl, qualsiasi riproduzione anche parziale sarà perseguita a norma di legge.		Materiale inox	Foglio 1/1